

Mast Height Extension - one hydraulic function needed.

Model	Capacity on LC 600 mm (kg)	Stroke (K) (mm)	L1/L2 (mm)	H1 (mm)	H2 (mm)	W1 (mm)	W2 (mm)	ET (mm)	C2 (mm)	CoG1 (mm)	CoGv1 (mm)	CoGv2 (mm)	Weight (mm)
MHEH 20 0300 550	2000	300	0860/1160	343	478	550	750	50	85	30	415	540	129
MHEH 20 0500 550		500	1020/1520		677					31	495	680	147
MHEH 20 0700 550		700	1220/1920		877					32	585	830	167
MHEH 20 1000 550		1000	1520/2520		1177					33	720	1045	197
MHEH 20 0300 800	2000	300	0860/1160	343	478	800	1000	50	85	28	415	550	152
MHEH 20 0500 800		500	1020/1520		677					29	495	695	172
MHEH 20 0700 800		700	1220/1920		877					30	580	850	190
MHEH 20 1000 800		1000	1520/2520		1177					32	710	1065	220
MHEH 30 0300 800	3000	300	0930/1230	343	587	800	1000	57	85	25	465	615	182
MHEH 30 0500 800		500	1130/1630		787					28	540	775	202
MHEH 30 0700 800		700	1330/2030		987					29	620	926	223
MHEH 30 1000 800		1000	1630/2630		1287					30	745	1150	253
MHEH 30 0300 1000	3000	300	0930/1230	343	587	1000	1200	57	85	23	450	610	210
MHEH 30 0500 1000		500	1130/1630		787					25	530	770	230
MHEH 30 0700 1000		700	1330/2030		987					27	600	930	250
MHEH 30 1000 1000		1000	1630/2630		1287					28	715	1163	280

- Possible in combination with KOOI-REACHFORKS®.
- Optional: quick change mounting hooks.
- Capacities shown are nominal and apply to the attachment and not the lift truck. Other capacities and dimensions on request.
- Remark: When tilting mast carriage please contact Meijer Handling Solutions.

Mast Height Extension

0612201701

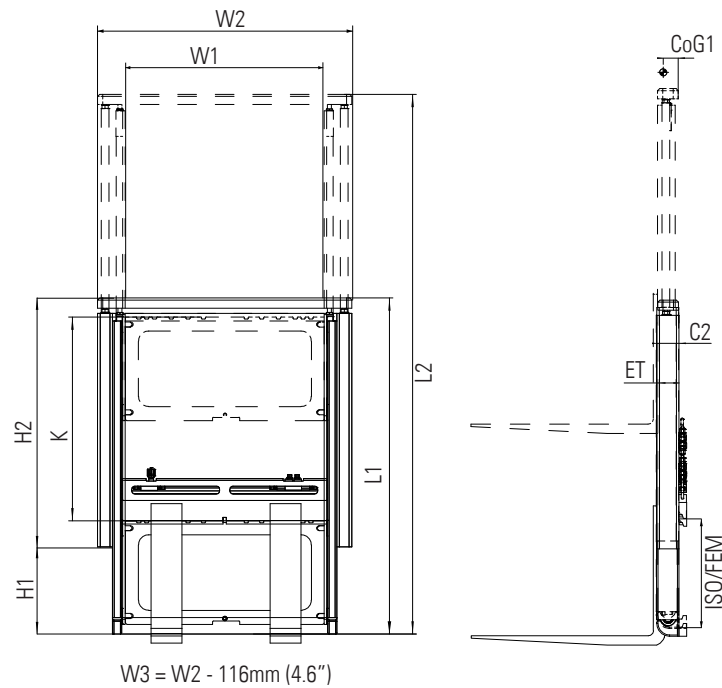

Model	Capacity on LC 24" (Lbs)	Stroke (K) (in)	L1/L2 (in)	H1 (in)	H2 (in)	W1 (in)	W2 (in)	ET (in)	C3 (in)	CoG1 (in)	CoGv1 (in)	CoGv2 (in)	Weight (Lbs)
MHEH 20 0300 550	4,400	11.8	32.3/44.1	13.5	18.8	21.7	29.5	2.0	3.3	1.2	16.3	21.3	284
MHEH 20 0500 550		19.7	40.2/59.8		26.7					1.2	19.5	26.8	323
MHEH 20 0700 550		27.6	48.0/75.6		34.5					1.3	23.0	32.7	367
MHEH 20 1000 550		39.4	59.8/99.2		46.3					1.3	28.3	41.1	433
MHEH 20 0300 800	4,400	11.8	32.3/44.1	13.5	18.8	31.5	39.4	2.0	3.3	1.1	16.3	21.7	334
MHEH 20 0500 800		19.7	40.2/59.8		26.7					1.1	19.5	27.4	378
MHEH 20 0700 800		27.6	48.0/75.6		34.5					1.2	22.8	33.5	418
MHEH 20 1000 800		39.4	59.8/99.2		46.3					1.3	28.0	41.9	484
MHEH 30 0300 800	6,600	11.8	36.6/48.4	13.5	23.1	31.5	39.4	2.2	3.3	1.0	18.3	24.2	400
MHEH 30 0500 800		19.7	44.5/64.2		31.0					1.1	21.3	30.5	444
MHEH 30 0700 800		27.6	52.4/79.9		38.9					1.1	24.4	36.5	491
MHEH 30 1000 800		39.4	64.2/103.5		50.7					1.2	29.3	45.3	557
MHEH 30 0300 1000	6,600	11.8	36.6/48.4	13.5	23.1	39.4	47.2	2.2	3.3	0.9	17.7	24.0	462
MHEH 30 0500 1000		19.7	44.5/64.2		31.0					1.0	20.9	30.3	506
MHEH 30 0700 1000		27.6	52.4/79.9		38.9					1.1	23.6	36.7	550
MHEH 30 1000 1000		39.4	64.2/103.5		50.7					1.1	28.1	45.8	616

- Possible in combination with KOOI-REACHFORKS®.
- Optional: quick change mounting hooks.
- Capacities shown are nominal and apply to the attachment and not the lift truck. Other capacities and dimensions on request.
- Remark: When tilting mast carriage please contact Meijer Handling Solutions.